

"A" BOARD

Model FLN6201B

Printed Circuit Board Details

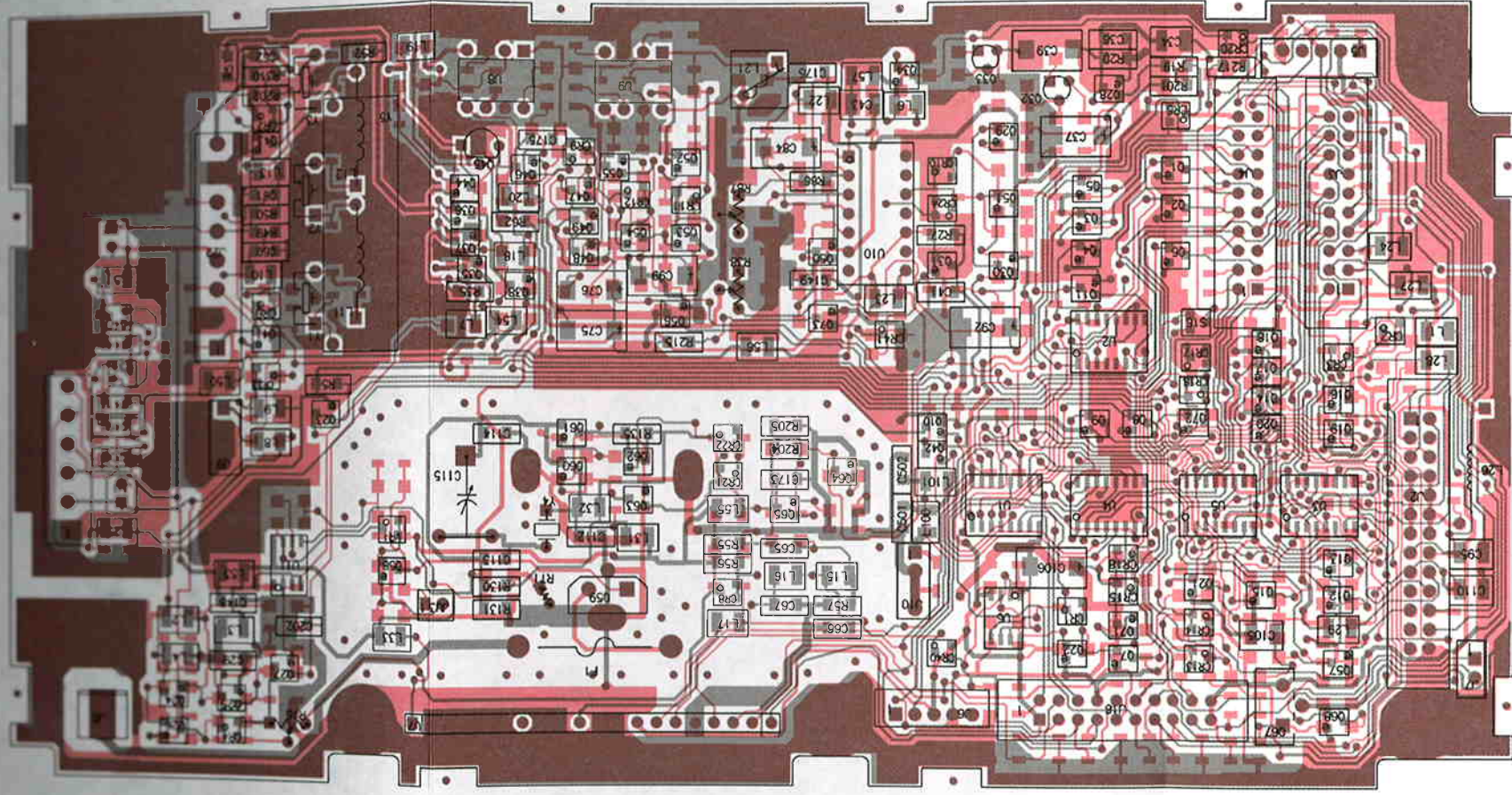

SHOWN FROM COMPONENT SIDE

- 79B02938C81-0 OVERLAY
- 79B02938C83-0 COMPONENT SIDE
- 79B02938C84-0 SOLDER SIDE

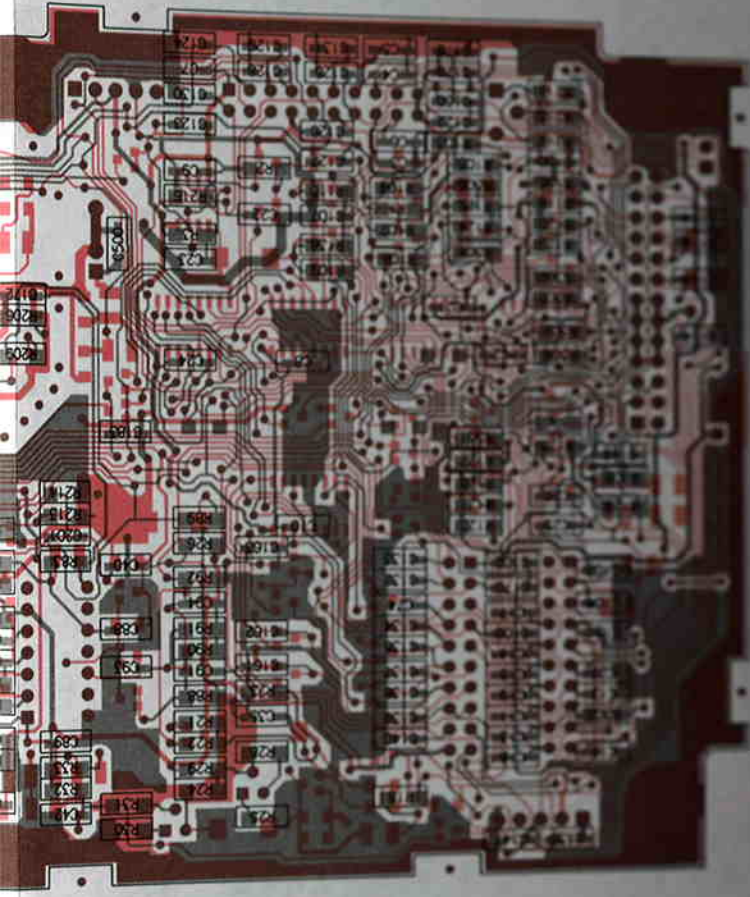

SHOWN FROM SOLDER SIDE

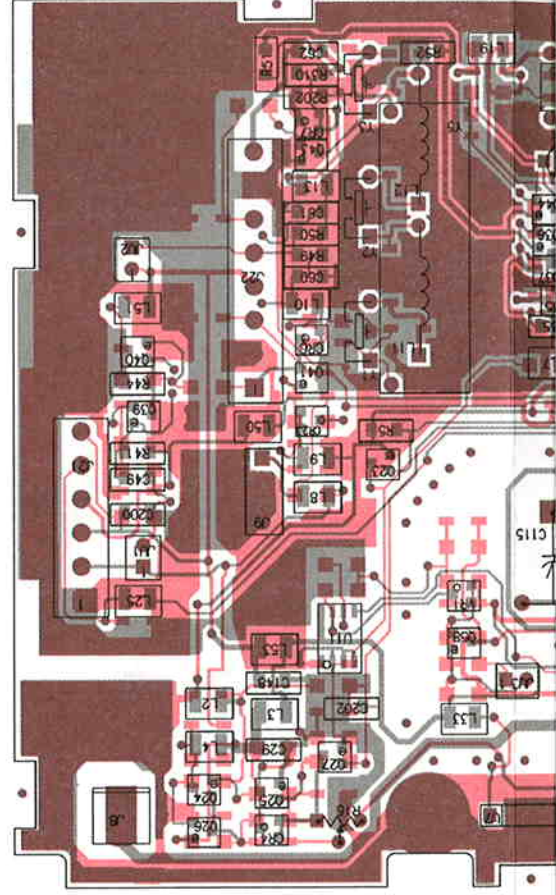

79802938C81-0
79802938C83-0
79802938C84-0

SHOWN FROM SOLDER SIDE

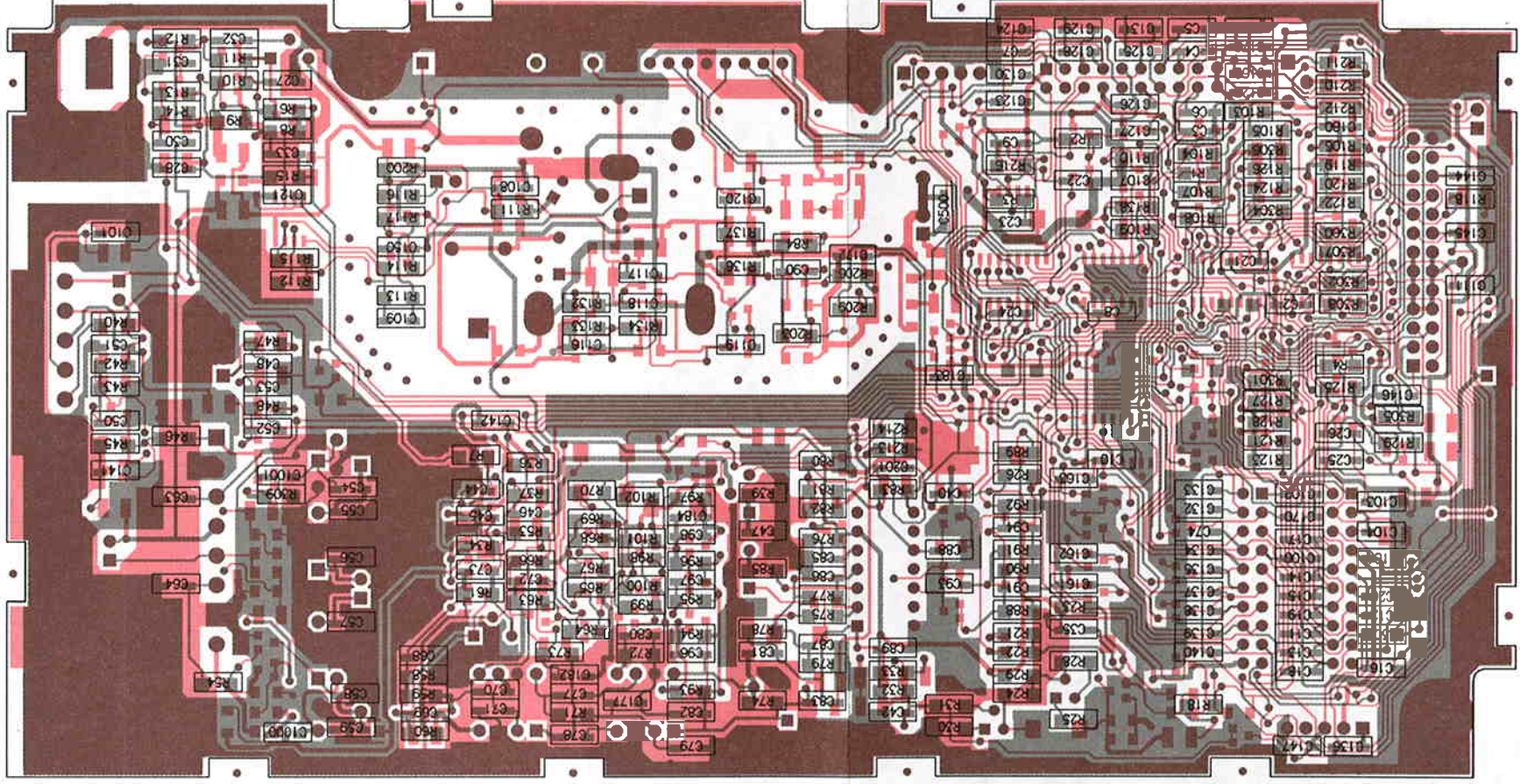

OVERLAY
 • 79802938C82-0 COMPONENT SIDE
 • 79802938C84-0 SOLDER SIDE

TO KEYBOARD

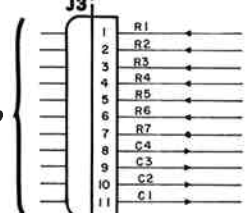

C BOARD

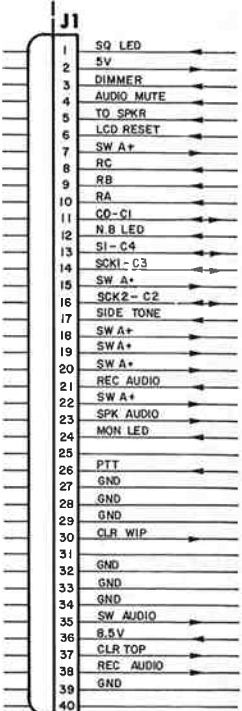

INTERCONNECT BOARD

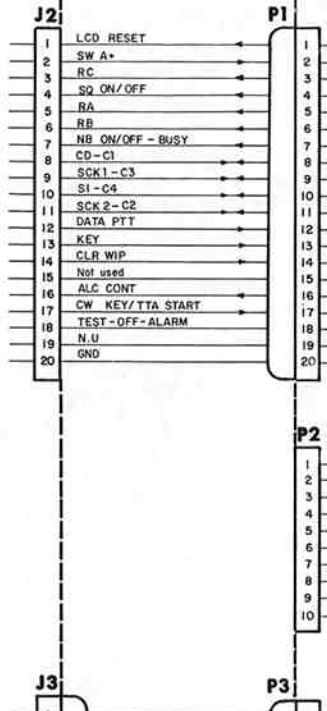

S BOARD

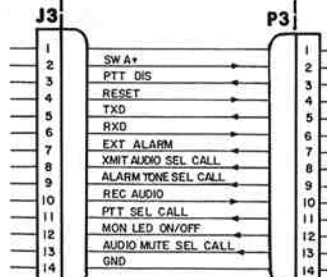

TO FRONT PANEL VIA FLEX CABLE

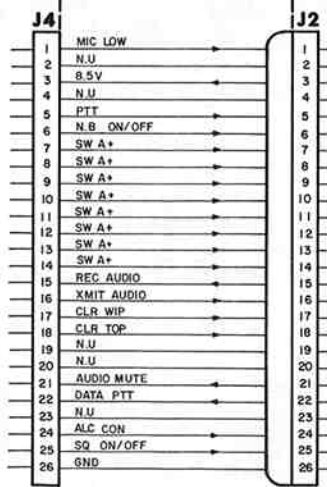
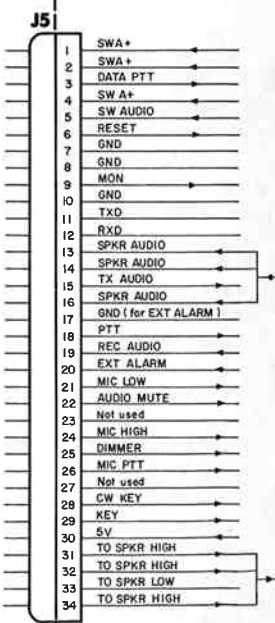

HARMONIC FILTER

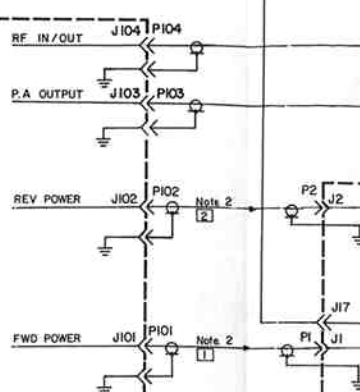

B BOARD

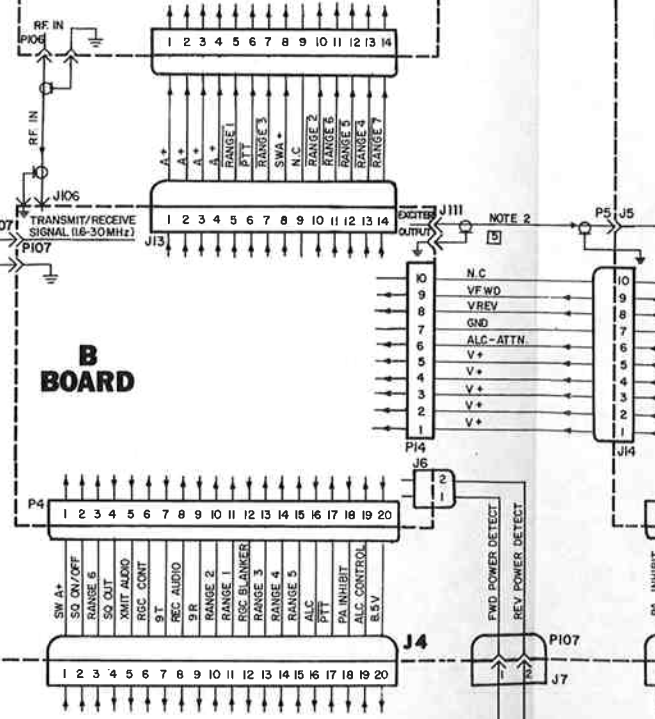

A BOARD

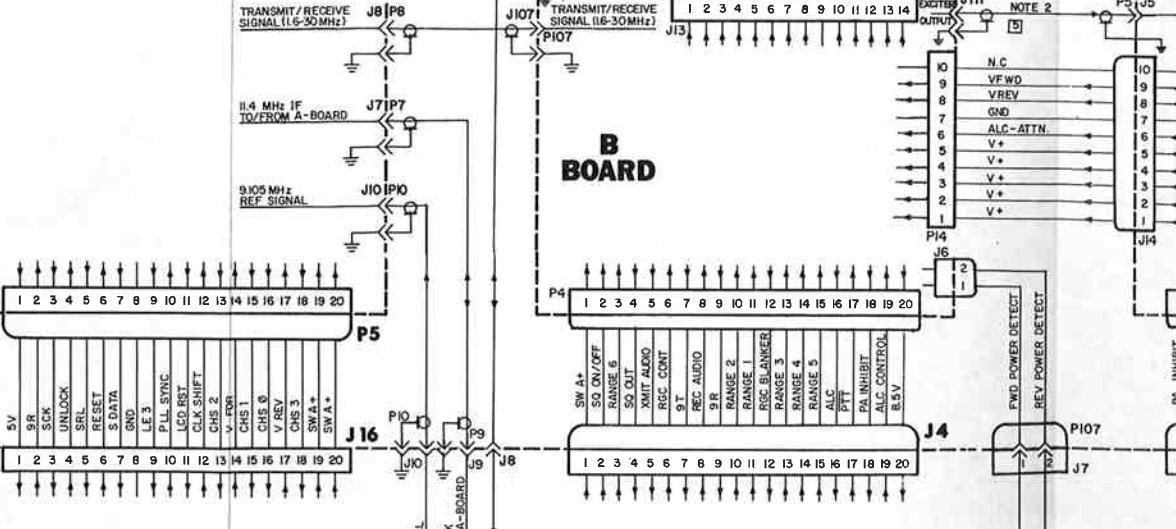

RADIO INTERCABLING DIAGRAM

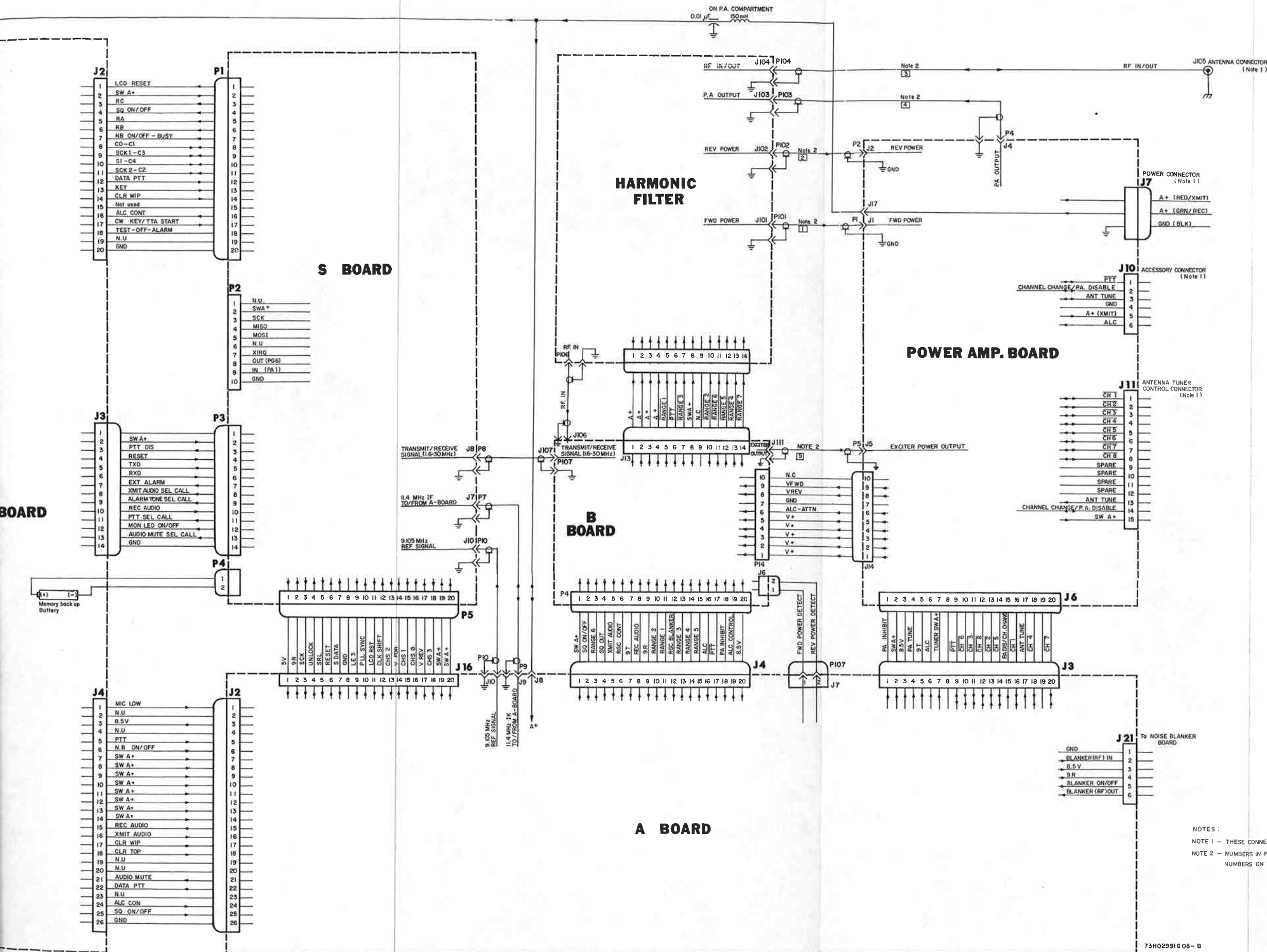

73H02991G 08-B